



MPM I

Electronic Seed Monitor



User Guide & Operator's Manual

TABLE OF CONTENTS - MPM 1

General information	1 - 3
Warnings and Alarms	4 - 5
Monitor Operation	6
Programming	7 - 10
Troubleshooting	11
Replacement Parts	12

GENERAL INFORMATION

MPM I Electronic Seed Monitor

The electronic seed monitor system consists of a console with non-volatile memory which is mounted in the tractor; seed tubes with computerized sensors, and a planting harness to which the individual seed tube sensors connect.

Seed flow for up to 36 rows, in two 18 row sections (left/right) may be monitored with one monitor.

The monitor system is powered by the tractor battery (requires 12 volts DC). The console receives information from each of the sensors and translates this information.

The single backlit Liquid Crystal Display (LCD) shows the active section, the number of monitored rows per section, the relative seed rate for each row (using a bar graph display) and scrolls various alarm and warning messages when a condition exists. A continuous audio alarm will sound upon system malfunction or underflow conditions for any monitored row. Alarms must be acknowledged by the user. Various warnings may sound the buzzer or flash one or more icons.

The monitor will power down if no activity is sensed for more than one hour. No activity means there has been no new seed flow and no operator push key input.

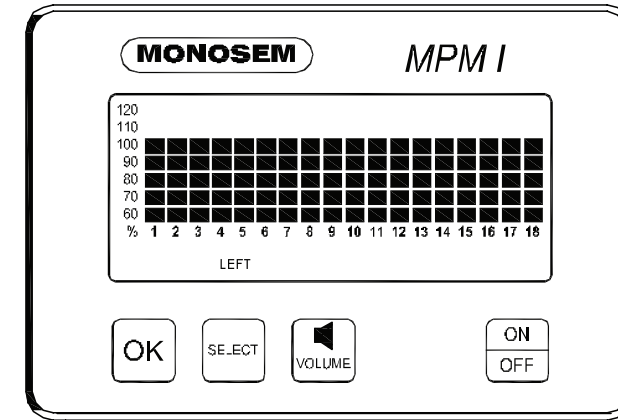

GENERAL INFORMATION

MONITOR KEY FUNCTIONS

Each key press is acknowledged by the monitor with a short beep.



OK

Ends and saves the new setup during installation. Acknowledges and silences alarms in the operation mode



SELECT

Selects the application mode (left/right) at the beginning of installation setup
Selects the active section(s) (left/right) in the normal mode.
Does not have an affect on a system that is configured to monitor only one section.



VOLUME

Pressing the key will turn the beeper on.
Holding the key for periods of 2 seconds increases the volume until it reaches the maximum, at which time it rolls over to the minimum level.

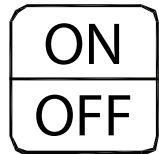

ON / OFF

Powers the unit on and off.

GENERAL INFORMATION

LCD FUNCTIONS

The monitor collects data on the planting rates from all active rows and calculates an average. This average will determine the 100% mark. Seed rate for each row is then compared to the average value and the result is displayed on the bar graph.

In the example below, rows 4 & 12 are indicating that they are planting 10% higher than average, where as rows 8 and 16 indicate 10% less than the average being planted.

The information regarding each section is displayed alternately every 5 seconds. While operating a system with two sections programmed, one or both sections may be selected any time. When only one section is selected, the monitor calculates the average based on the remaining active rows from that section.

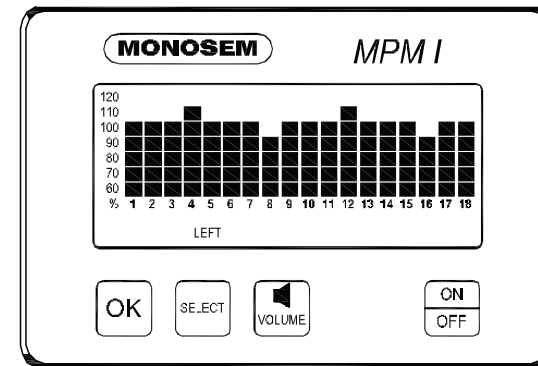

SELECTING SECTIONS

Press **SELECT** key once to show one section. The flashing icon shows the section that is not selected. The selected section is continuously displayed on the LCD.

Press **SELECT** key again to activate both sections. Ex: Press **SELECT** key second time. The information regarding each section will display alternately every 5 seconds. For simple applications, where only one section is programmed, the display will automatically lock on that section. Pressing **SELECT** key will have no affect.

NOTE: When alternating between two sections, the display will lock on the section containing the first recognized alarm until the alarm is acknowledged by pressing the **OK** key or the alarm condition is removed.

CHANGING THE AUDIO VOLUME

Press and hold down the **VOLUME** key.

The **SETUP** and **VOLUME** icons will turn on and the beeper will sound continuously. The intensity of the sound will change every 2 seconds. After the maximum volume is reached, the next change will set the volume to a minimum and will continue to get louder every 2 seconds. When the desired volume is reached, release the key.

WARNINGS AND ALARMS

SYSTEM ALARMS

A system alarm is entered when the monitor detects a faulty sensor or one of several other communication faults.

The corresponding row number starts flashing and the beeper sounds. All segments on the corresponding bar graph are turned off. Pushing the **OK** key to acknowledge the alarm will turn the beeper off. The row number will continue to flash until the alarm condition is removed. If the monitor detects a faulty sensor and there is no planting activity present, the monitor will scroll “CHECK CONNECTION”

UNDER FLOW ALARMS

If the seed rate for one or more rows is less than 55% of the calculated average, the corresponding 60% segment will stay on, the corresponding row number starts flashing and the alarm sounds. Pushing the **OK** key to acknowledge the alarm will turn the alarm off. The 60% segment of the bar graph remains on and the row number continues to flash until the alarm condition is corrected.

NOTE: All alarms present within a short time before planting stops, are frozen on the screen and the text **LOW** or **FAIL** will display on the LCD. If the underflow is between 0%-10%, this warrants a **FAIL** condition. If the underflow is between 10%-55%, a **LOW** condition is generated. If multiple rows have an underflow condition, **FAIL** will display if any one or more rows is between 0%-10%. This allows the user to identify and fix the problem rows.

NOTE: This warning will not trigger unless a minimum time of continuous planting has passed.

NOTE: If all the rows show a seed rate of zero, the condition will not generate an alarm. It will be assumed the planter has stopped. The row numbers and the bottom 60% segment will remain on for all selected rows.

MULTIPLE ALARMS

If more than one alarm condition occurs at the same time, pushing the **OK** key will acknowledge all alarms that are currently displayed. For example, if one row on the left and one row on the right is alarming; pushing the **OK** key will only acknowledge one of them. However, if there are two alarms on the left, both alarms would be acknowledged with one push of the **OK** key.

SECTION NOT SELECTED WARNING

If the monitor was programmed for two sections and only one is currently selected for the display (by pressing the **SELECT** key), the icon of the disabled section will flash for a period of 1 minute, then turn off at each power up. If seed flow is sensed in the disabled section, the icon for that section (left or right) will begin to flash.

WARNINGS AND ALARMS

SEED PLANTING STOPPED

When the monitor detects no seed flow on all rows, the monitor will emit 3 short beeps to alert the user. This warning will occur each time the planter is stopped, each time the planter is raised at the end of a row or if the mechanical drive fails while planting.

NOTE: This warning will not trigger unless a minimum time of continuous planting has passed.

SEED COUNTING SENSOR IN CALIBRATION WARNING

All seed counting sensors run a self calibration sequence on power up. While in calibration the bottom segment of each corresponding bar graph will flash if the monitor detects movement or planting activity. If the monitor does not detect this, the message **WAIT CALIBRATION** will be scrolled.

SEED COUNTING SENSOR TOO DIRTY WARNING

After the seed counting sensors end their internal self calibration, the monitor may detect one or more sensors are either too dirty or blocked. If the monitor detects planting or movement, the corresponding bar graph remains flashing. The monitor will display **CLEAN SENSORS** on the LCD if no movement or planting is detected, prompting the user to clean the tubes. If the tubes are dirty, they will still show seed flow with less accuracy. If the tubes are blocked the user will get an alarm as soon as planting starts. The corresponding bar graph will remain flashing until the problem is corrected and the monitor is powered down and then powered back up.

LOW BATTERY WARNING

The monitor is constantly monitoring its input voltage to quickly detect low power conditions. If the monitor detects that the input voltage has dropped below 10.5V, it will display **LOW POWER** on the LCD, provided that the monitor does not detect planting.

NOTE: After the alarms have been acknowledged and if the alarm condition is still present, the LCD will continue to display the alarm condition.

MONITOR OPERATION

REPLACING A FAULTY SENSOR

To replace a faulty sensor:

- Turn the monitor off
- Disconnect the faulty sensor
- Turn the monitor back on
- Plug in the replacement sensor.

The monitor will chirp twice to acknowledge the new sensor was learned and saved.

To replace more than one faulty sensor, proceed as stated above beginning with the lowest numbered row in the left section and continue to replace sensors in increasing order. Then move on to the right section and continue in increasing row number order.

NOTE: If the monitor is not turned off and then on, the replacement sensor(s) will be ignored until the next power on, at which point they will be randomly learned by the monitor.

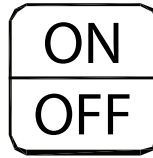

FIELD OPERATION

Press the **ON/OFF** key to turn the monitor on & off
Information regarding each section is displayed alternately every 5 seconds.



LEFT / RIGHT CONFIGURATION

Press the **SELECT** key once to show **LEFT** section only.
Press the **SELECT** key a second time to show **RIGHT** section only
Press the **SELECT** key a third time to return to each section being displayed alternately every 5 seconds.

NOTE: SELECT key has no function when only a single section is being used.



VOLUME

Press the **VOLUME** key to increase or decrease volume. See “**Changing the Audio Volume**”

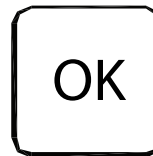

OK

Press the **OK** key to silence alarms. See “**Warnings and Alarms**”

PROGRAMMING

NOTE: The following steps only apply to systems that were not preprogrammed at the factory.

- 1.** ALL the seed tubes with sensors must be disconnected from the harness and the monitor must be off.
- 2.** Press the **ON** key. The monitor automatically enters the setup procedure. If the monitor was accidentally powered on with no sensors attached, the user can turn the monitor off at this point and the previous configuration is not lost.
- 3.** Press the **SELECT** key. Each time you press the **SELECT** key the mode will toggle between left/right. The selected display will be solid and the configuration not currently selected will be flashing.

- 4.** Press and hold the **OK** key to confirm the selection and continue holding until the row numbers appear on the display. During confirmation, the display will alternate between **NEW** and **SYS** to alert the user that the previous configuration will be lost. With the left/right mode selected, the monitor automatically starts with the left section. The **LEFT** icon shows solid and the **RIGHT** icon starts to flash.

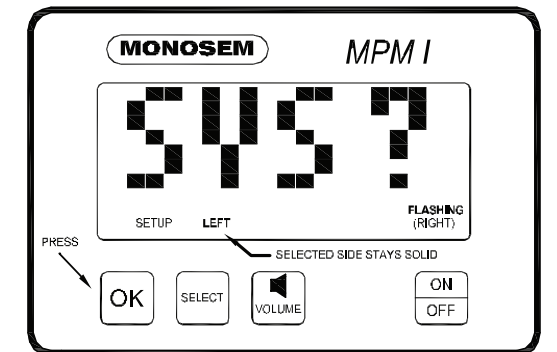
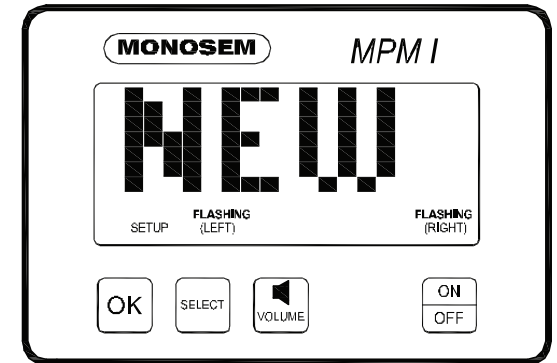

PROGRAMMING

5.

Plug each seed tube with sensor into the harness in a predetermined order.

Row 1 first, Row 2 second and so on up to 18 rows.

When a sensor is plugged in, the corresponding row number on the LCD display will stay solid, the monitor will chirp twice and the LED (Light Emitting Diode) on the seed tube sensor will turn on for approximately 30 seconds to show connection is made.

NOTE: Unless there is a faulty sensor, the installer should just have to connect the sensors in the proper order without checking the monitor to acknowledging each sensor

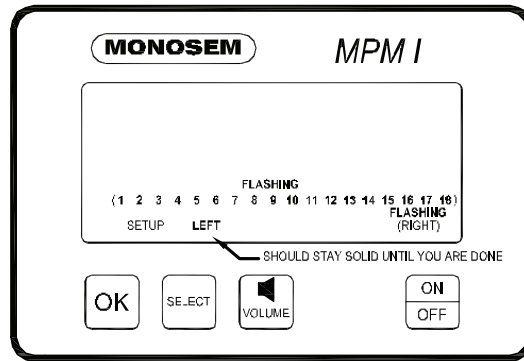

6.

When all the seed tubes with sensors for the current section are installed, check to be sure the monitor displays solid numbers for the number of sensors connected.

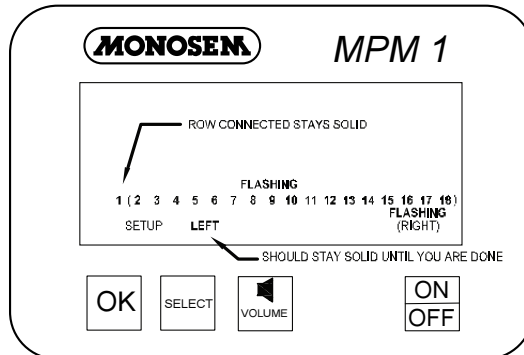

7.

If this condition is satisfied,

press and hold the OK key to save the setup for the current section.

The SAVE? icon will show followed by continuous short beeps indicating the monitor is preparing to save.

The installer has five seconds to decide if he wants to save the current configuration.

During this time short beeps will sound. To complete the save, hold the OK key pressed until the word DONE shows on the screen followed by a long beep and the SAVE? icon turns off.

When the OK key is released the monitor will continue with the second section installation.

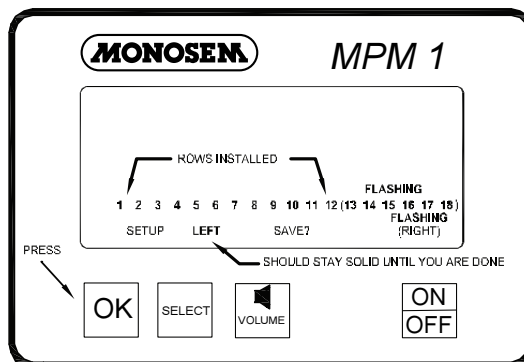

PROGRAMMING

Follow steps 5 thru 7 to install the second section.

If no seed tubes are installed on the second section, press and hold the OK key until the word DONE shows on the screen followed by a long beep and the SAVE? icon turns off.

NOTE: Individual seed tubes may be unplugged for special situations. An alarm will sound which can be silenced by touching the OK key. The monitor will recognize the seed tube(s) when reconnected.

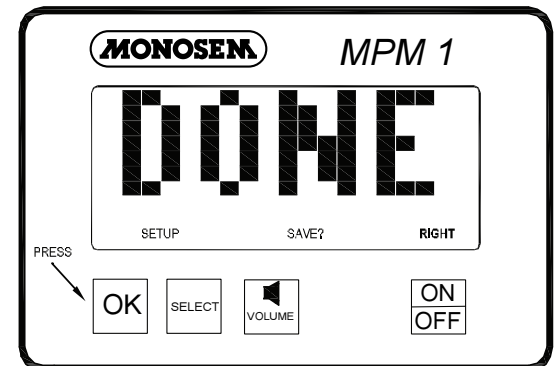
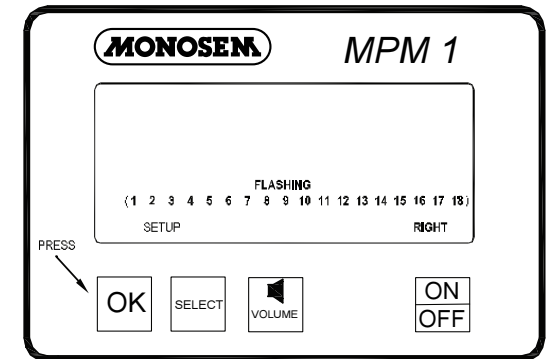
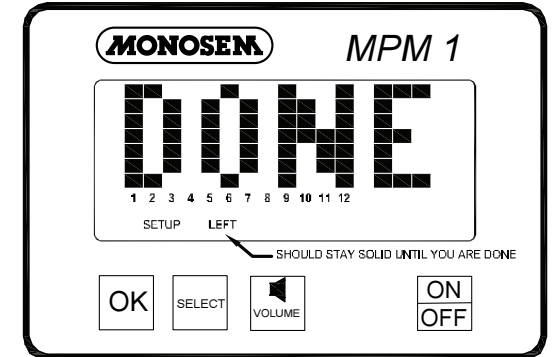

PROGRAMMING

The words **WAIT CALIBRATION** will scroll across the display. This simply means that the monitor is running a check of all the sensors. The red light on the back of each sensor will be illuminated while this check is taking place. After the monitor completes this “check”, it will go to the field operation mode, as shown to the right.

NOTE: Each time the monitor is powered up, the words **WAIT CALIBRATION** will scroll across the display. This indicates that the console is running a check of all the sensors. After several seconds, the check will be completed and if all sensors are functional the display will show the field operation mode.

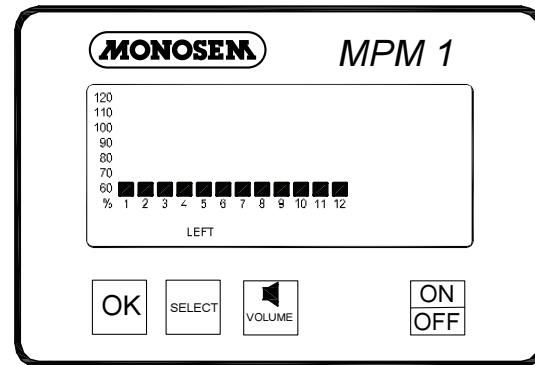
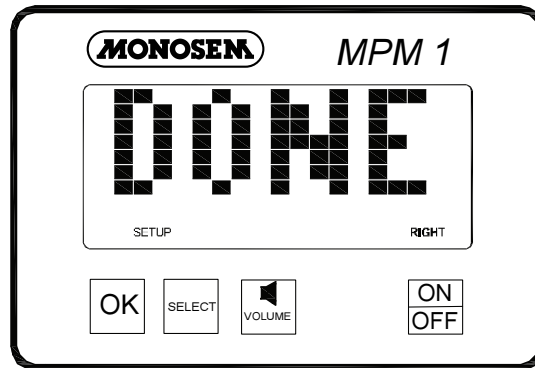

TROUBLESHOOTING

PROBLEM: Single Sensor communication alarm comes on (alarm on with no bar graph and a blinking row number on a single row)
Faulty seed tube sensor. -Replace Sensor.
Break in the harness just before the seed tube sensor. -Inspect for break in harness and repair. If break can't be found, replace harness section.
The connector is dirty or corroded.-Clean connector.

PROBLEM: Sensor communication alarms come on for all sensors (alarm on with no bar graphs and blinking row numbers on all rows.)
The monitor is faulty. -Replace monitor
Break in the harness just after the monitor. -Inspect for break in harness and repair. If the break can't be found, replace harness section.
Connector is dirty or corroded. -Clean connector.

PROBLEM: Sensor communication alarms come on for some sensors (alarm on with no bar graphs and blinking row numbers on all rows.)
Break in the harness. -Inspect for break in harness and repair. If break can't be found, replace harness section corresponding with the alarming sensors.
Connector is dirty or corroded -Clean connector.

PROBLEM: The alarm "Under planting" or "no planting" sounds on a single sensor while planting. (Alarm on with a single bar graph segment on and a blinking row number on a single row.)
Seed tube sensor is blocked.-Clean sensor.
Faulty seed tube sensor. - Replace sensor.

PROBLEM: Seed tube sensor dirty or blocked warning comes on (after calibration, bar graph keeps blinking for a single row.)
Seed tube is dirty. -Clean sensor.
Faulty seed tube sensor. -Replace sensor.

PROBLEM: LED on the seed tube sensor will not come on.
Faulty seed tube sensor. - Replace sensor.
Connector is dirty or corroded -Clean connector.
Break in the harness just before the sensor.
- Repair harness.

PROBLEM: System low error message
Pinched wire on harness. - Repair or replace harness.

PROBLEM: COP error message appears
Internal console error. -Press **OK**. If this doesn't help, reprogram the monitor. If still malfunctioning, send in for service.

PROBLEM: Monitor not reading population.
Radar is possibly not working. - Turn console on and unplug radar wire. Look for radar on error message. If faulty replace radar.

REPLACEMENT PARTS

ITEM	PART #	DESCRIPTION
1	VA598004	MPM I monitor console*
2	VA598005	MPM II monitor console*
		*Includes MPM console, mounting bracket, power adapter cable and cleaning brush.
3	L318954	4-row Harness
3	L318956	6-row Harness
3	L318958	8-row Harness
3	L318962	12-row Harness
3	L318966	16-row Harness
3	L318974	24-row Harness
3	L318986	36-row Harness
		other harness available
4	VA598003	Seed tube with sensor
	VA598503	Seed tube only
5	VA598H03	Sensor only
6	VA291009	Mux adaptor, ground speed
7	VA598708	Y Adaptor harness for MDS
8	KA6147	Magnetic Distance Sensor Kit
9	KD8751	Magnetic Distance Sensor Pulse Wheel
10	KD8771	Spring wave washer
11	VMO355519	Cleaning brush
12	VA48377	Power adapter cable

REPLACEMENT PARTS

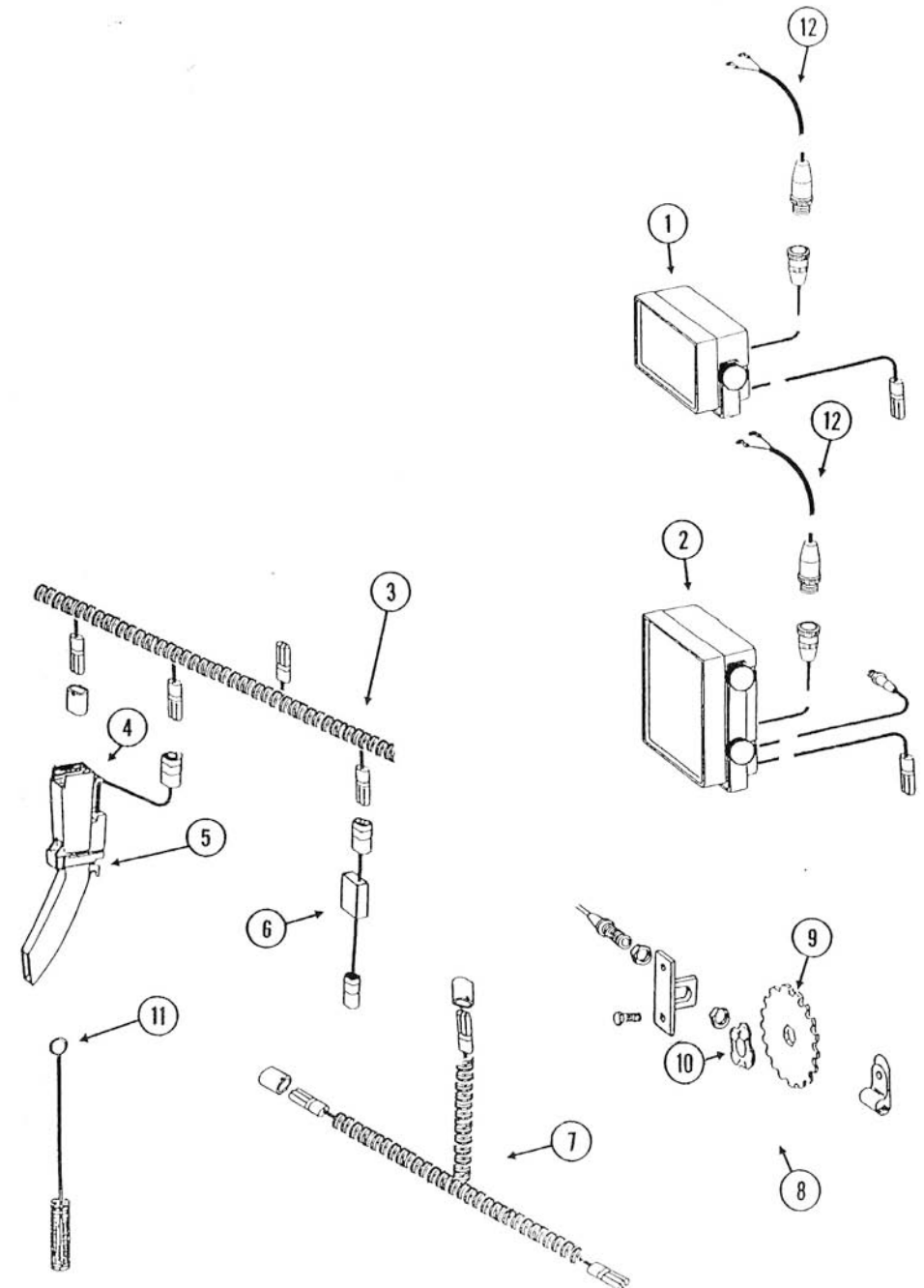

Precision Planting Counts.



30 Years of Research and Innovation in every planter.

MONOSEM Inc.

17135 W. 116th St. Lenexa, KS 66219
Phone (913) 438-1700 Fax (913) 438-5455
www.monosemplt.com